

Thank you for purchasing the **Bankable 60" Bookcase**. This page lists all the contents included in the box. Please take the time to identify the hardware as well as the individual components to this product. As you unpack and prepare for assembly, place the contents on a carpeted or padded area to protect them from damage.

Note: 2 people are required to safely assemble this product.

 **WARNING: Adult Assembly Required**

## ASSEMBLY HARDWARE

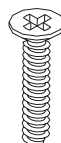

26 - bolts



26 - spring washers



26 - flat washers



26 - screws



26 - wood dowels

Missing hardware? Please call **800.933.9904** for replacements.  
NOTE: Contains small parts. Keep away from small children.

## TOOLS REQUIRED

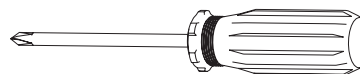

Phillips head screwdriver

(We recommend the use of hand tools instead of power tools)

## COMPONENTS

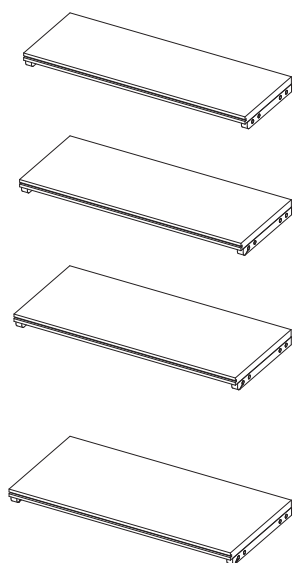

4 - shelves  
(shown in smallest to largest)

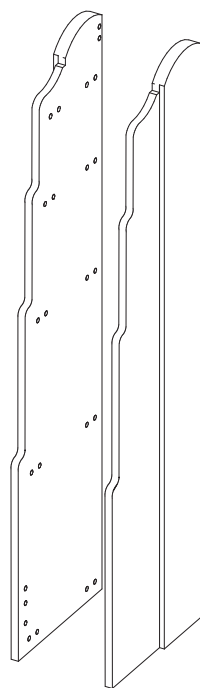

2 - side panels  
(1 left, 1 right)



3 - back panels  
(1 left, 1 center, 1 right)

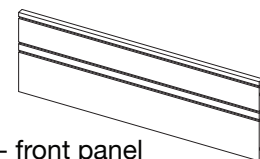

1 - front panel

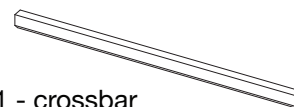

1 - crossbar

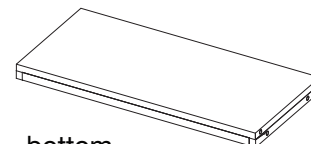

1 - bottom panel

left side panel

right side panel

**1** Place **left and right side panels** onto a clean, padded surface as shown. Insert 13 **wood dowels** into **left and right side panels** as shown.

smallest shelf

largest shelf

NOTE: Make sure apron and front edge of each shelf are positioned as shown

right side panel

NOTE: Do not over tighten the bolts

**2** A. Set **left side panel** aside. Fit 4 **shelves (from smallest to largest)** onto corresponding dowels of **right side panel** as shown.  
B. Using a **phillips head screwdriver**, attach each **shelf** with 2 **bolts**, 2 **spring washers** and 2 **flat washers** as shown. Do not over tighten the bolts.

front panel

bottom panel

**3** A. Fit **bottom panel** and **front panel** onto dowels of **right side panel**. Secure front/bottom panels with 4 **bolts**, 4 **spring washers** and 4 **flat washers** as shown.  
B. Secure **bottom panel** to **front panel** with 2 **bolts**, 2 **spring washers** and 2 **flat washers** as shown.

**B** left side panel

**A** crossbar

**4** A. Fit **crossbar** onto dowel of **right side panel** as shown.  
B. Fit **left side panel** onto corresponding dowels of assembly and secure with 12 **bolts**, 12 **spring washers** and 12 **flat washers** as shown.

NOTE: Do not over tighten the screws

right back panel

left back panel

x 16

5 With the assistance of another adult, position assembly upright as shown. Attach **left and right back panels** to back of assembly with **8 screws** per panel. Secure, but do not over tighten, screws with a screwdriver.

x 10

center back panel

6 Attach **center back panel** with **10 screws** as shown. Assembly is now complete.

## CLEANING AND CARE

Clean surfaces with a dry or damp soft cloth. Do not use abrasive cleaners. Do not use furniture wax or polish as the unit is finished with a protective clear lacquer.

# **WARNING**

**Serious or fatal crushing injuries can occur from furniture tip over. Use of tip-over restraints may only reduce, but not eliminate, the risk of tip-over. To help prevent tip-over, install tip restraint per instructions below.**

## MOUNTING HARDWARE

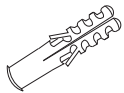

4 - plastic anchors



4 - small screws

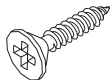

4 - large screws

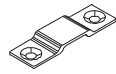

4 - mounting brackets

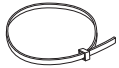

2 - wall straps

Missing hardware? Please call **800.933.9904** for replacements. NOTE: Contains small parts. Keep away from small children.

## TOOLS REQUIRED

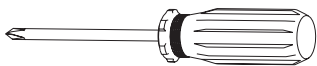

phillips head screwdriver

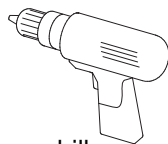

power drill  
(for pilot holes only)

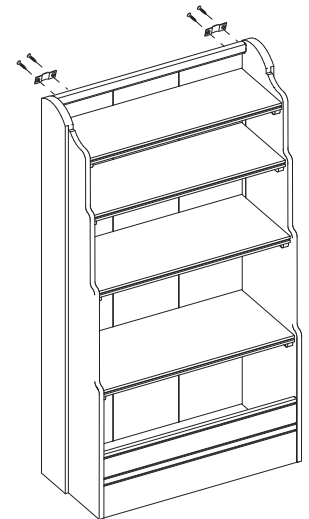
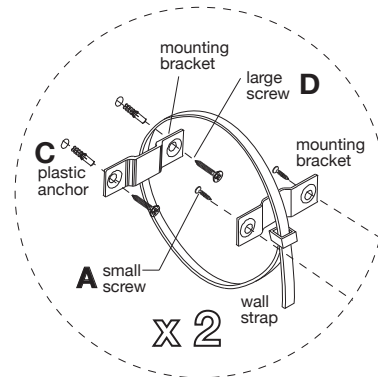

## WALL MOUNTING ASSEMBLY

For added safety and stability, it is recommended that the wall mounting hardware be installed. For safe mounting, it is essential to use wall anchors appropriate to your wall type (i.e. plaster, drywall, concrete, etc.). Mount to wood studs whenever possible.

- A) Attach 2 **mounting brackets** to back of unit using 2 **small screws** per bracket as shown.
- B) Determine the final location of unit. Mark position on the wall, approximately 2" below each wall bracket mounted to the back of the unit.
- C) Drill holes into marked positions on the wall and into a wall stud. If the wall stud is not available, drill a hole in the wall that is slightly smaller in diameter than the anchor. Gently tap 4 **plastic anchors** until the flange of each anchor is flush with the wall.
- D) Attach 2 **mounting brackets** to the wall by inserting 2 **large screws** per bracket. Using a screwdriver, make sure each screw is secured through the mounting bracket and into the plastic anchor in the wall.
- E) With assistance of another adult, position the unit so the mounting brackets on the back edge are aligned with the mounting brackets on the wall.
- F) Attach 2 **wall straps** to corresponding mounting brackets as shown. Lace one end of the **wall strap** through both brackets and into the other end of the strap. Pull tightly on the wall strap to secure.

Wall mounting assembly is now complete.