

Thank you for purchasing the **5 Cube Bookcase Tower**. This page lists all the contents included in the box. Please take the time to identify the hardware as well as the individual components to this product. As you unpack and prepare for assembly, place the contents on a carpeted or padded area to protect them from damage.

Note: 2 people are required to safely assemble this product.

### HARDWARE



24 - wood dowels

24 - bolts

24 - spring washers

24 - flat washers

22 - screws

Missing hardware? Please call **800.933.9904** for replacements.  
NOTE: Contains small parts. Keep away from small children.

**! WARNING: Adult Assembly Required**

### TOOLS REQUIRED

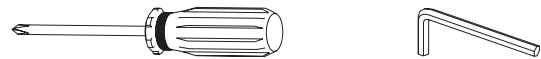

Phillips head screwdriver    allen wrench (included)  
(We recommend the use of hand tools instead of power tools)

### COMPONENTS

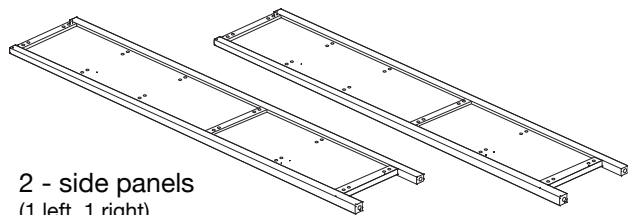

2 - side panels  
(1 left, 1 right)

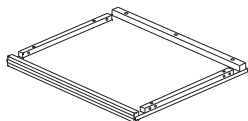

1 - top panel

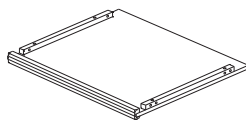

1 - bottom panel

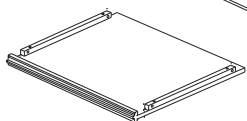

4 - shelves

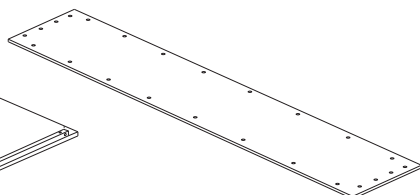

1 - back panel

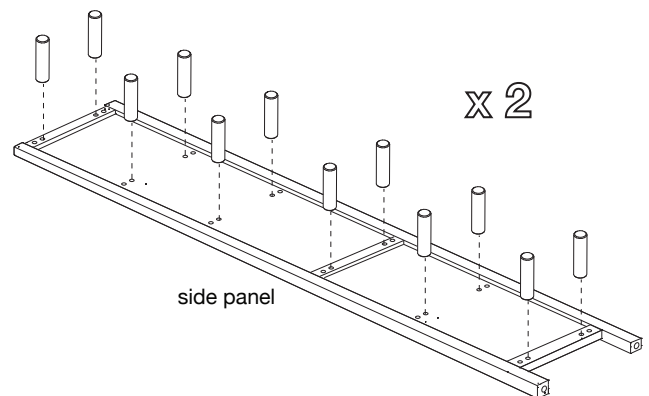

**1**

Insert 12 **wood dowels** into each **side panel** as shown.

NOTE: Do not over tighten the bolts

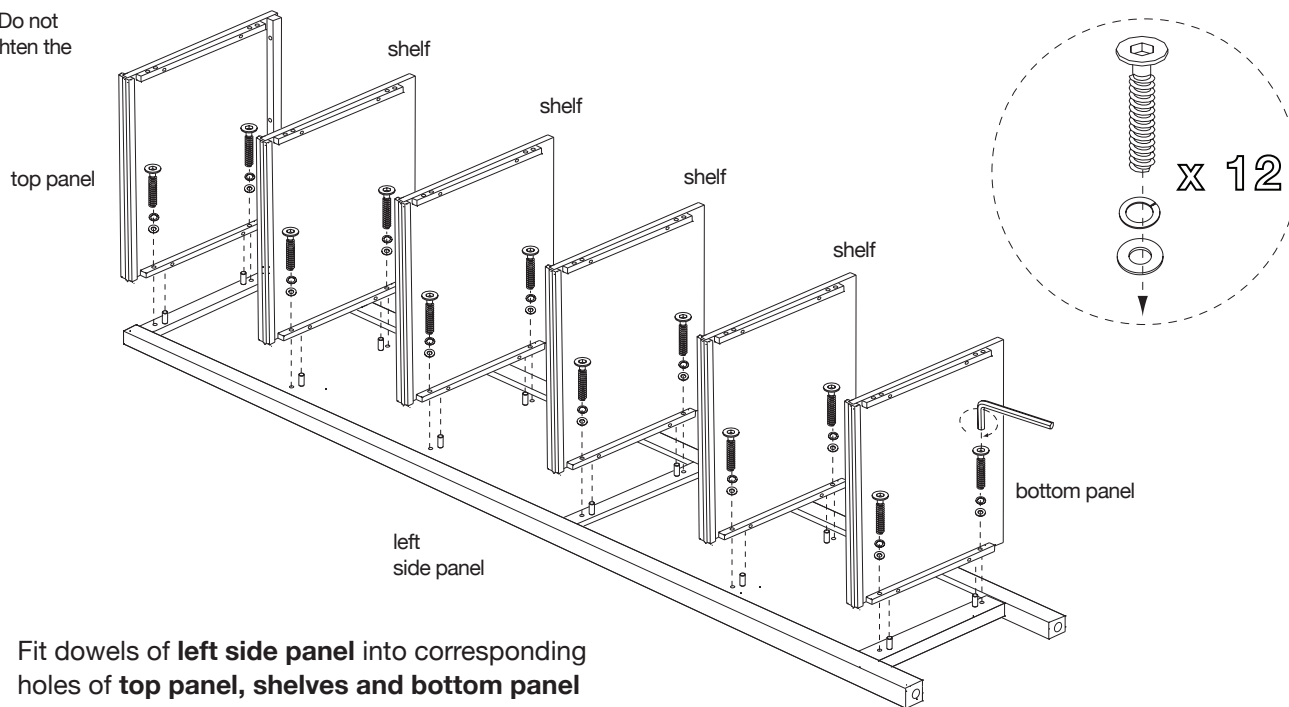

Fit dowels of **left side panel** into corresponding holes of **top panel, shelves and bottom panel** as shown. Secure each panel with 2 **bolts**, 2 **spring washers** and 2 **flat washers** using an **allen wrench**. Do not over tighten the bolts.

2

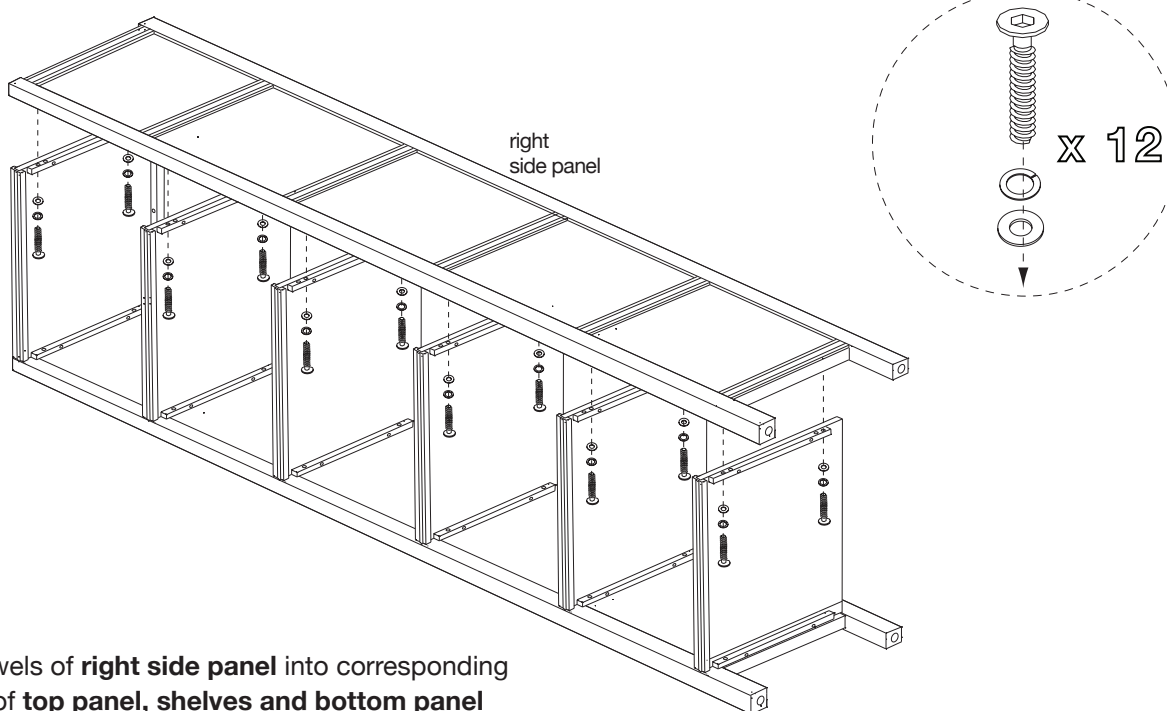

Fit dowels of **right side panel** into corresponding holes of **top panel, shelves and bottom panel** as shown. Secure each panel with 2 **bolts**, 2 **spring washers** and 2 **flat washers**.

3



With the assistance of another adult, carefully place assembled unit upright as shown. Attach **back panel** to assembly with 22 **screws**, using a screwdriver.

Assembly is now complete.

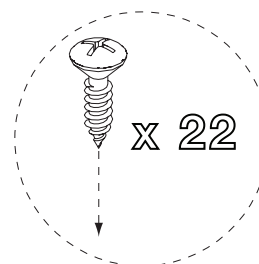

4

## CLEANING AND CARE

Clean surfaces with a dry or damp soft cloth. Do not use abrasive cleaners. Do not use furniture wax or polish as the unit is finished with a protective clear lacquer.

# ! WARNING

**Serious or fatal crushing injuries can occur from furniture tip over. Use of tip-over restraints may only reduce, but not eliminate, the risk of tip-over. To help prevent tip-over, install tip restraint per instructions below.**

## MOUNTING HARDWARE



2 - wall straps

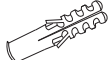

4 - plastic anchors



4 - small screws

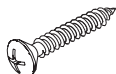

4 - large screws

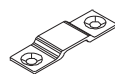

4 - mounting brackets

Missing hardware? Please call 800.933.9904 for replacements.  
NOTE: Contains small parts. Keep away from small children.

## TOOLS REQUIRED

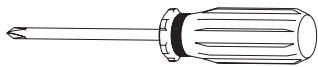

phillips head screwdriver

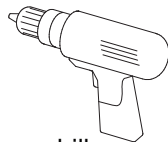

power drill  
(for pilot holes only)

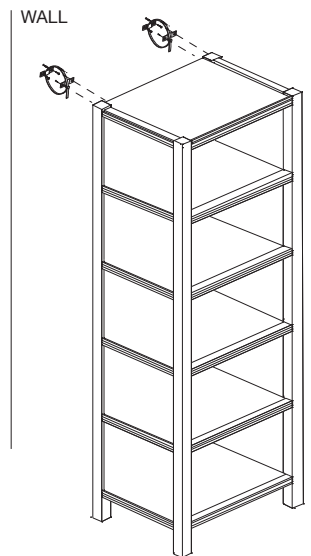
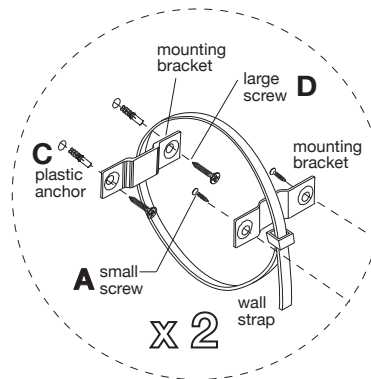

## WALL MOUNTING ASSEMBLY

For added safety and stability, it is recommended that the wall mounting hardware be installed. For safe mounting, it is essential to use wall anchors appropriate to your wall type (i.e. plaster, drywall, concrete, etc.). Mount to wood studs whenever possible.

- A) Attach **mounting bracket** to top center of unit using 2 **small screws**.
- B) Determine the final location of unit. Mark position on the wall, approximately 2" below the mounting bracket mounted to the back of the unit.
- C) Drill a hole in the wall stud. If the wall stud is not available, drill a hole in the wall that is slightly smaller in diameter than the anchor. Gently tap the **plastic anchor** until the flange of the anchor is flush with the wall.
- D) Attach the **mounting bracket** to the wall by inserting 2 **large screws** through the mounting bracket and into the wall anchor in the wall.
- E) Place the unit so the mounting bracket on the back edge is allowed with the wall bracket.
- F) Lace one end of the **wall strap** through both brackets, and into the other end of the strap.
- G) Pull the strap tightly until secure.

Repeat step A-G for remaining wall mounting assembly.

**NOTE: If you are unsure about your wall type or what mounting method you should use, consult a qualified professional.**

Wall mounting assembly is now complete.