

Thank you for purchasing the **Mojo Table**. This page lists all the contents included in the box. Please take the time to identify the hardware as well as the individual components to this product. As you unpack and prepare for assembly, place the contents on a carpeted or padded area to protect them from damage.  
Note: 2 people are required to safely assemble this product.

## HARDWARE

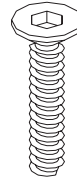

8 - large bolts

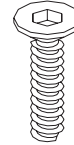

12 - small bolts



4 - wood dowels

Missing hardware? Please call **800.933.9904** for replacements.

NOTE: Contains small parts. To avoid danger of choking, keep away from small children.



**WARNING: Adult Assembly Required**

## TOOLS REQUIRED

allen wrench (included)



## COMPONENTS

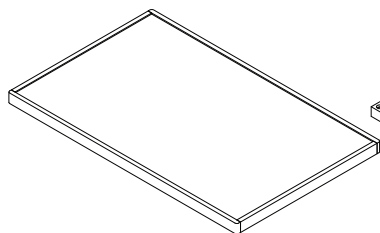

1 - tabletop

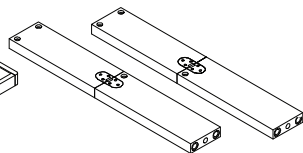

4 - legs  
(2 left, 2 right)

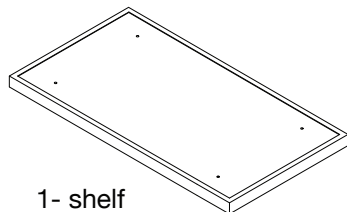

1 - shelf

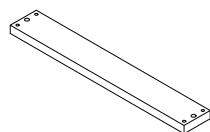

2 - crossbars

NOTE: Do not over tighten the bolts.

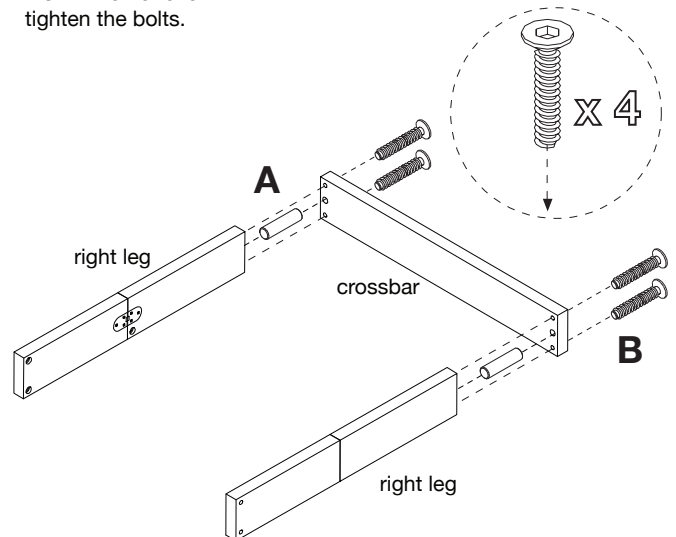

A. Insert 2 **wood dowels** into **crossbar** as shown.  
B. Fit dowels of **crossbar** into corresponding holes of 2 **right legs**. Secure, but do not over tighten, each leg with 2 **large bolts** using an **allen wrench**.

**1**

**2**

A. Insert 2 **wood dowels** into **crossbar** as shown.  
 B. Fit dowels of **crossbar** into corresponding holes of 2 **left legs**. Secure each leg with 2 **large bolts**.

**3**

With the assistance of another adult, fit **shelf** into **right and left leg assembly** as shown. Secure with 4 **small bolts** using an allen wrench.

### ASSEMBLY FOR TABLE WITH SHELF

With the assistance of another adult, attach **left and right leg assembly** of assembled unit to **tabletop** as shown. Secure each side with 4 **small bolts**. Position unit upright. Assembly is now complete.

### ASSEMBLY FOR TABLE WITHOUT SHELF

A. Position assembled unit upright. Fold **legs** of **left and right leg assembly** onto **shelf** as shown.  
 B. With the assistance of another adult attach **tabletop** to assembled unit with 4 **small bolts**. Assembly is now complete.

## CLEANING AND CARE

Clean surfaces with a dry or damp soft cloth. Do not use abrasive cleaners. Do not use furniture wax or polish as the unit is finished with a protective clear lacquer.